

Figure 1

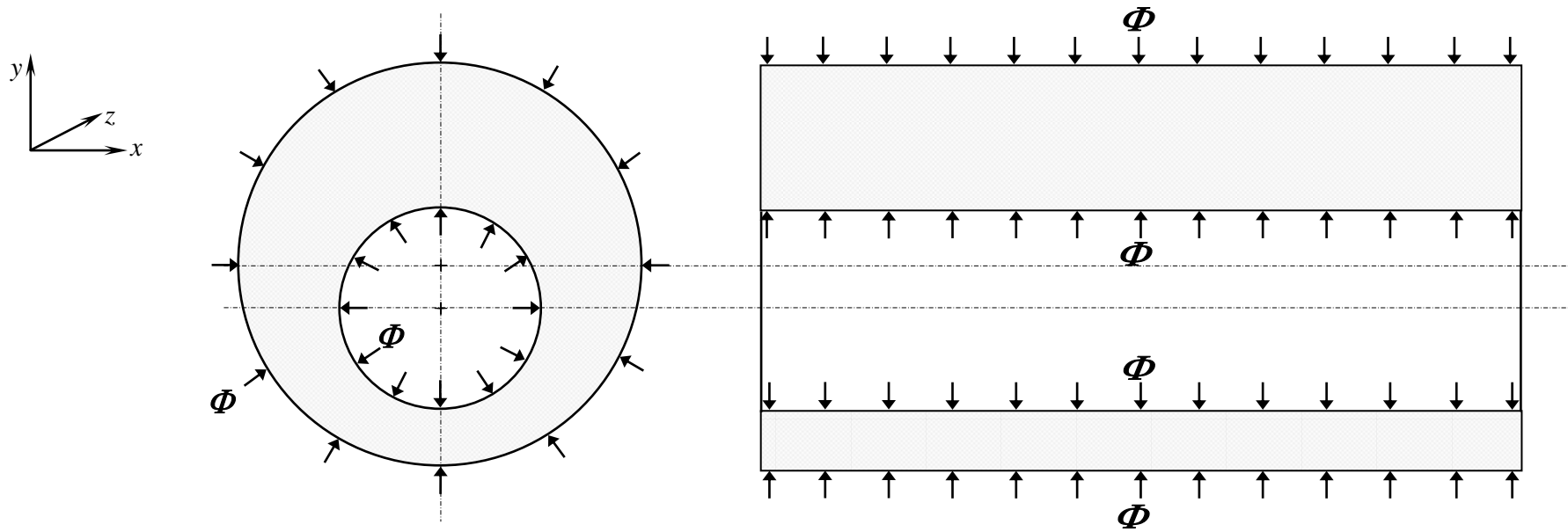

Figure 2

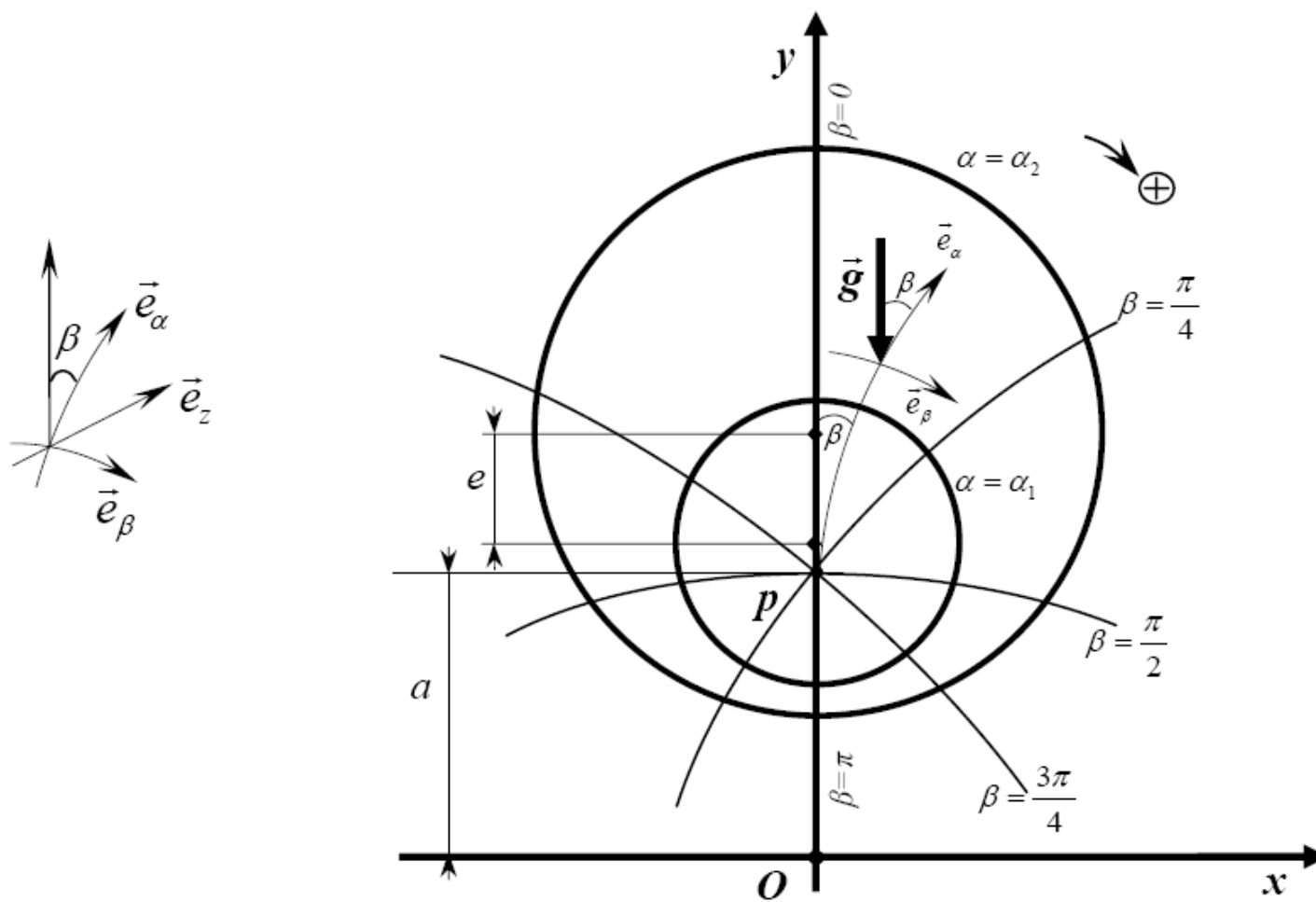

Figure 3

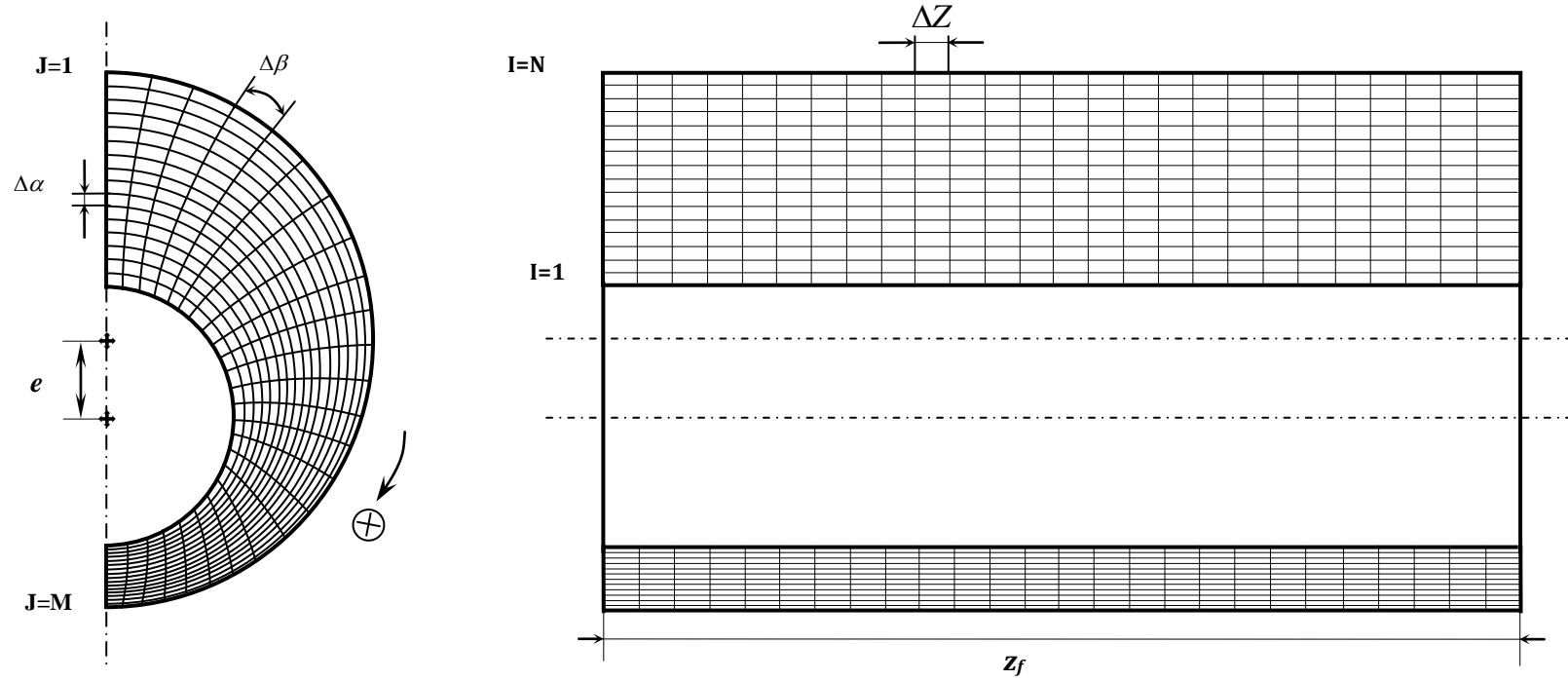
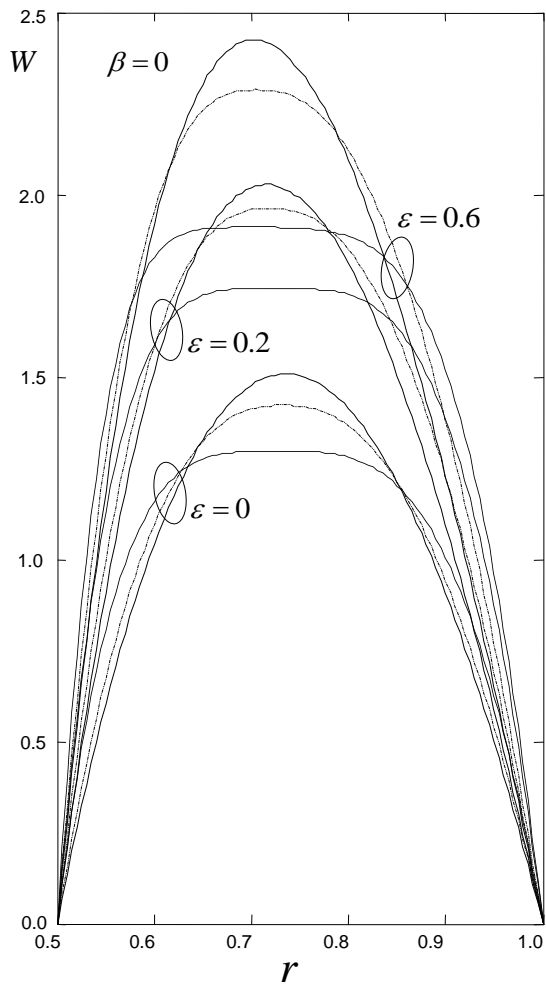
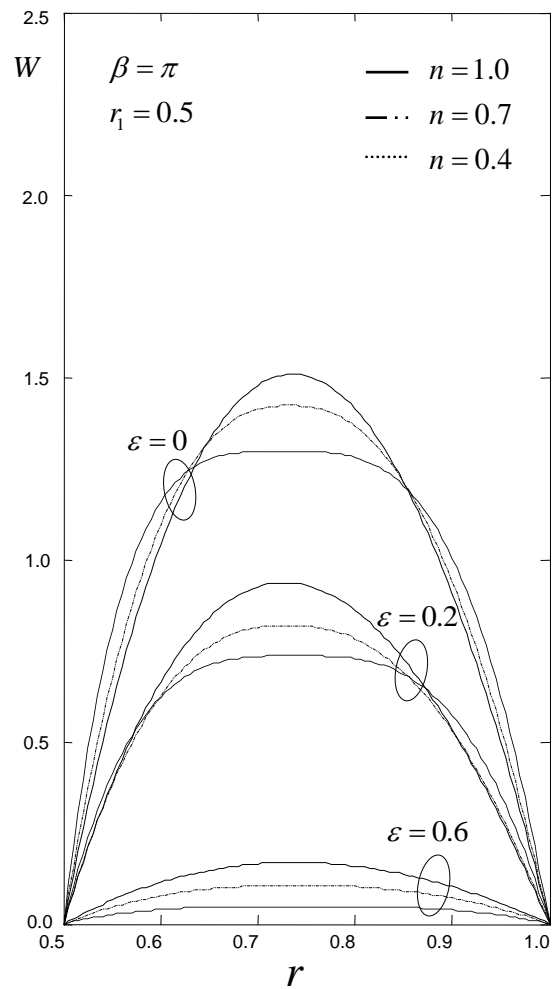

Figure 4



(a)



(b)

Figure 5

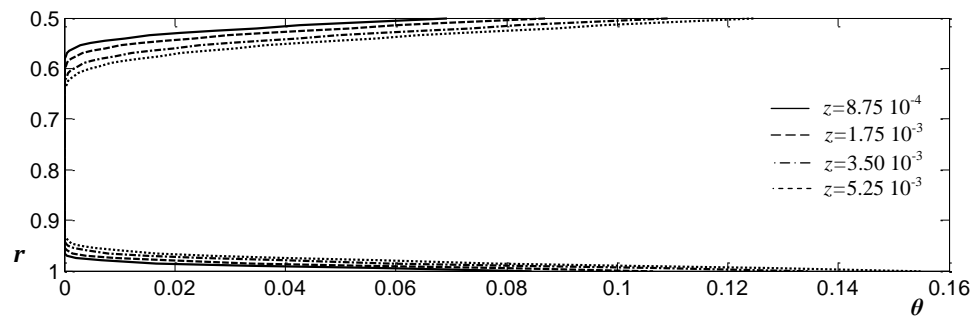
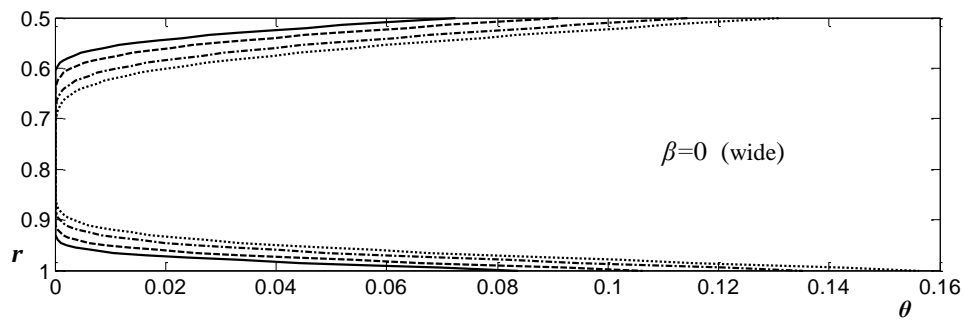
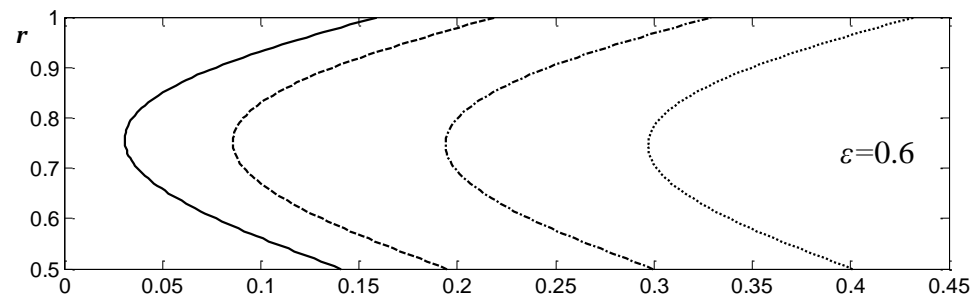
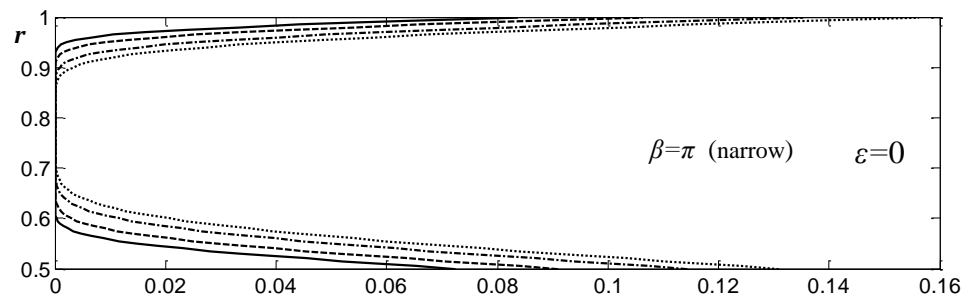

(a)

(b)

Figure 6

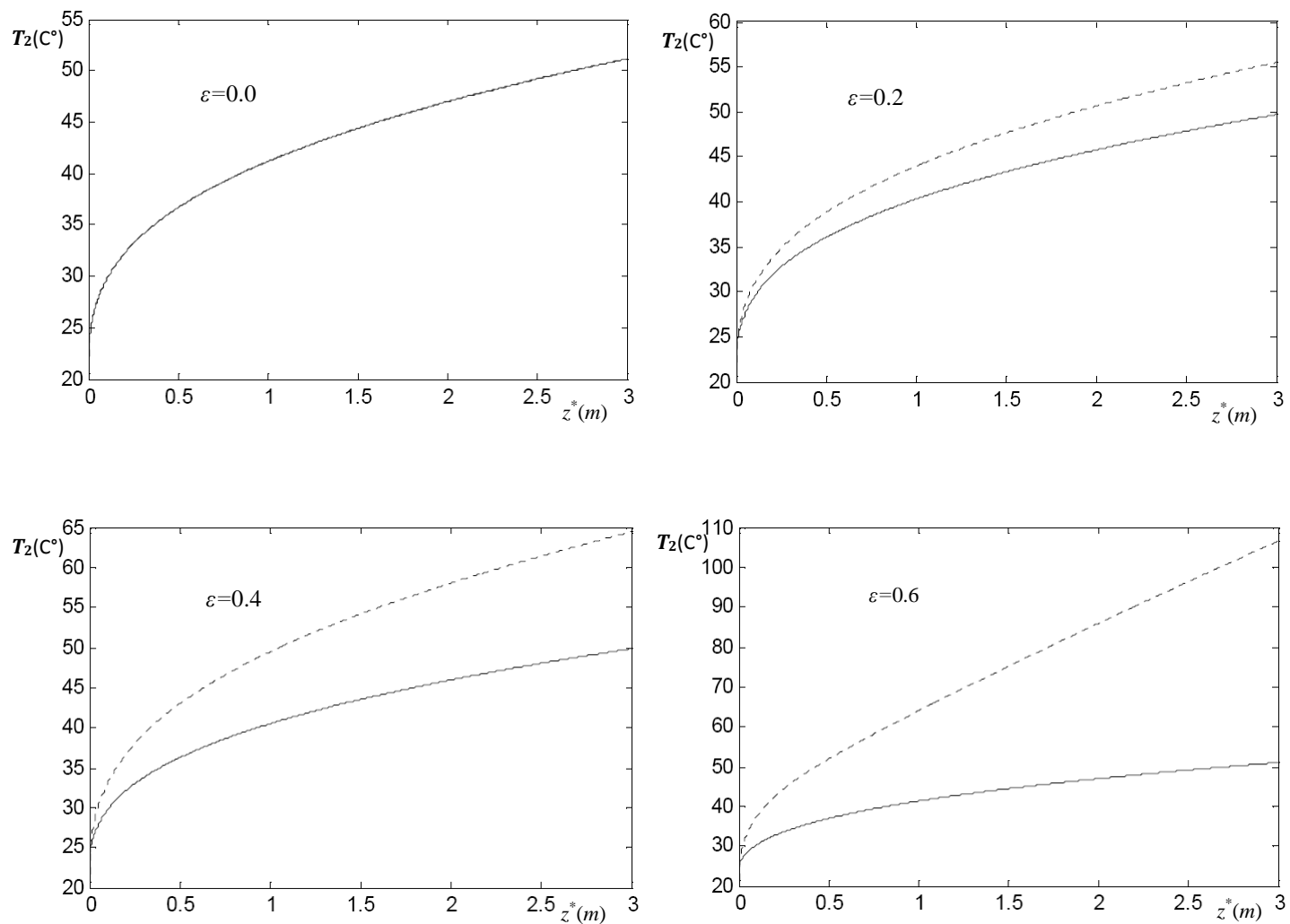
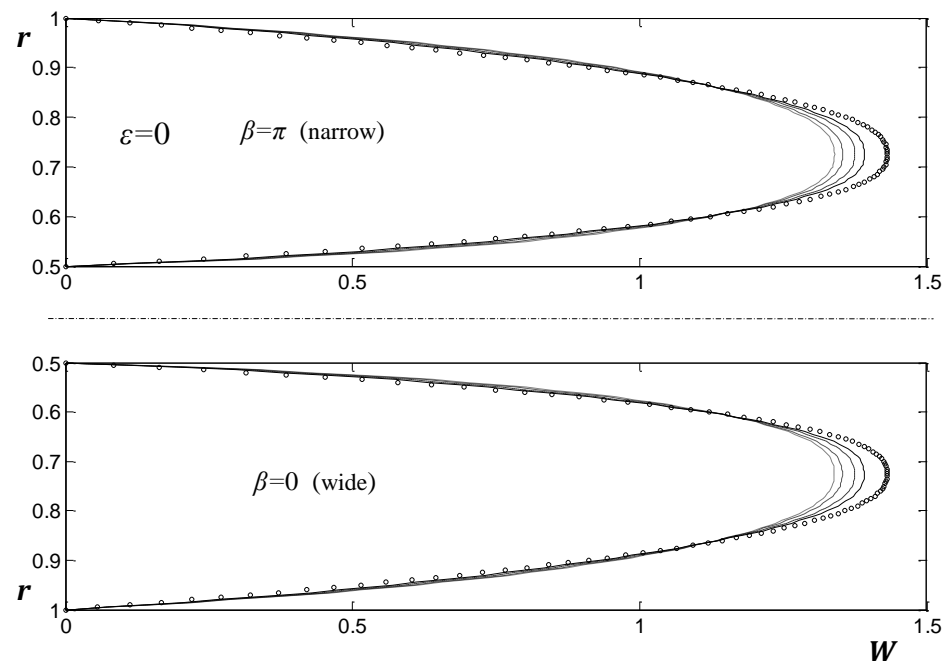
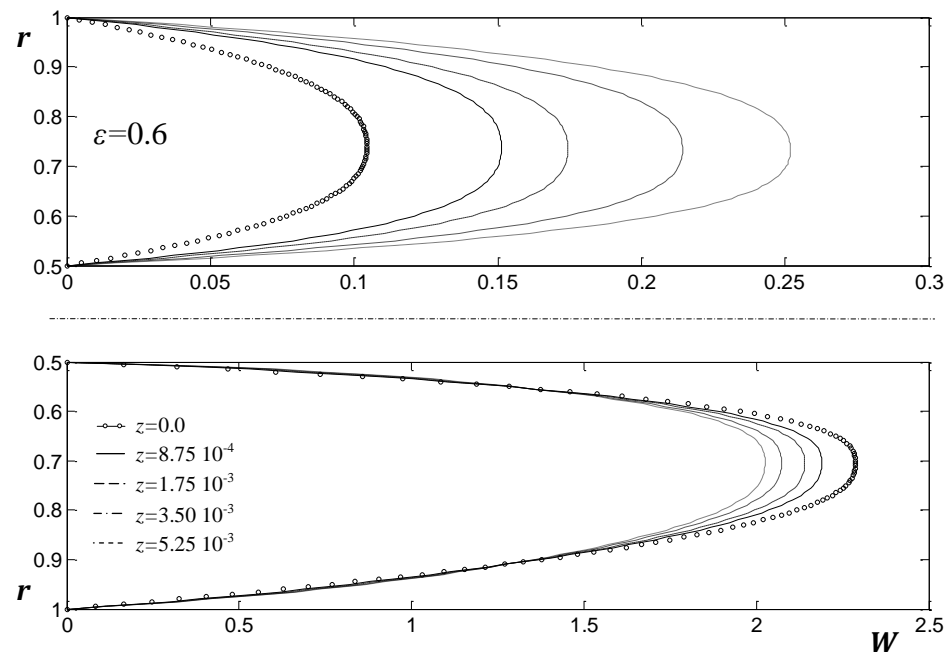

Figure 7



(a)



(b)

Figure 8

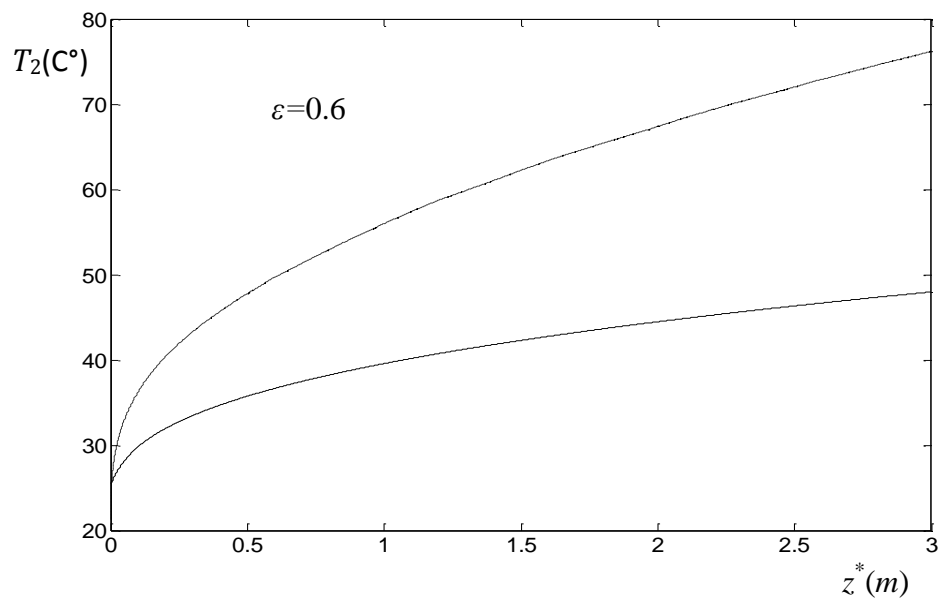



Figure 9

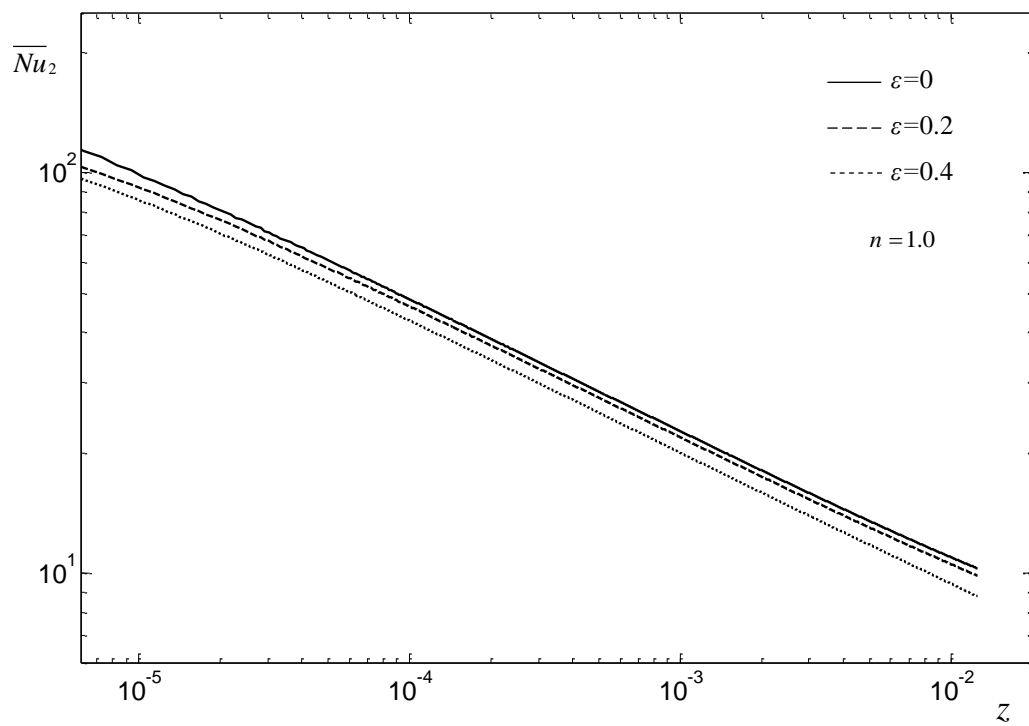

Figure 10

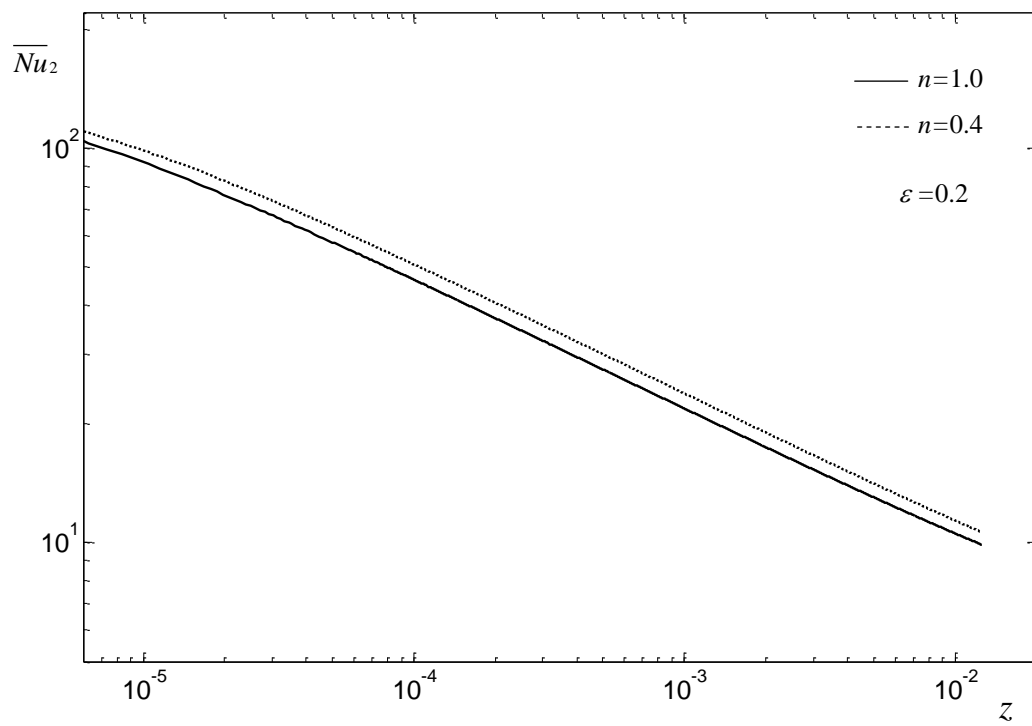

Figure 11

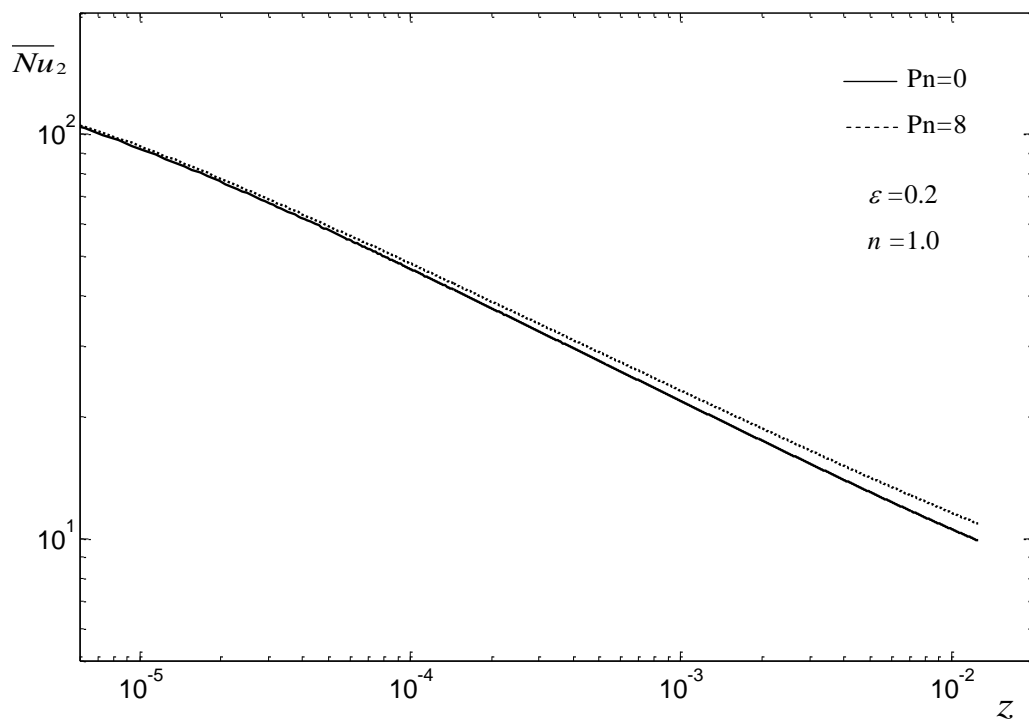

Figure 12

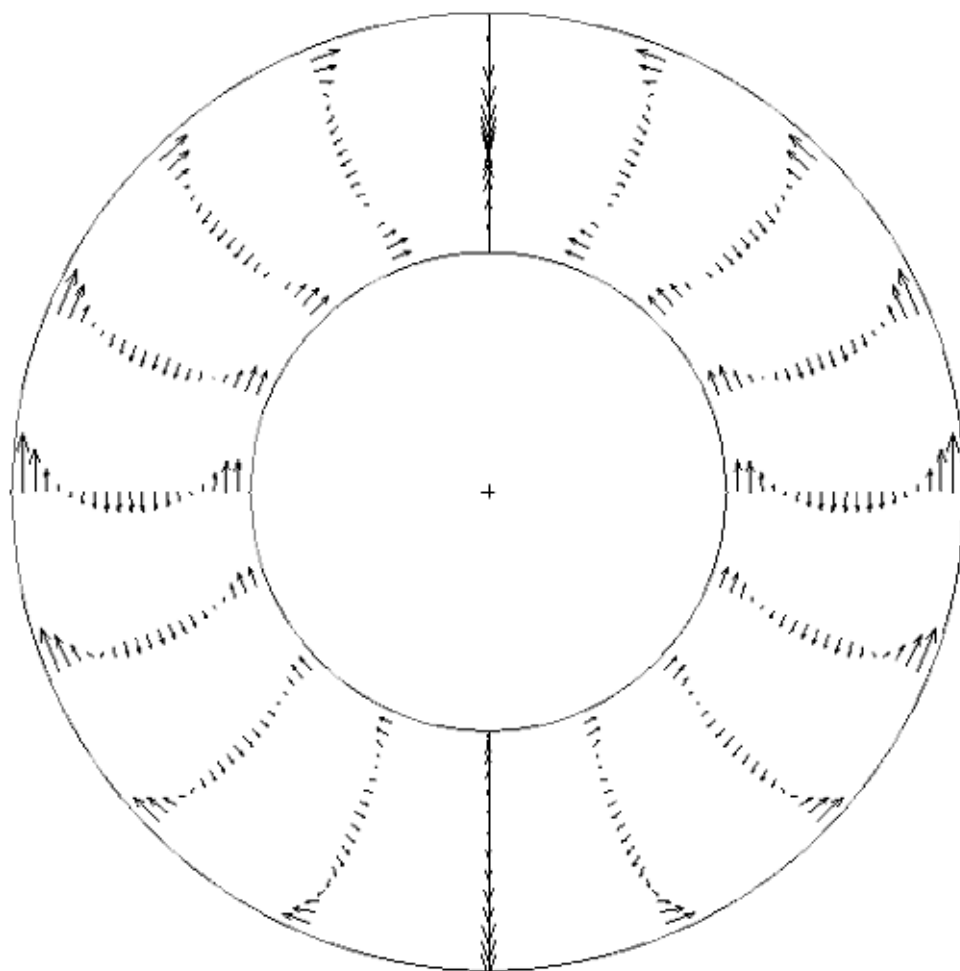

Figure 13

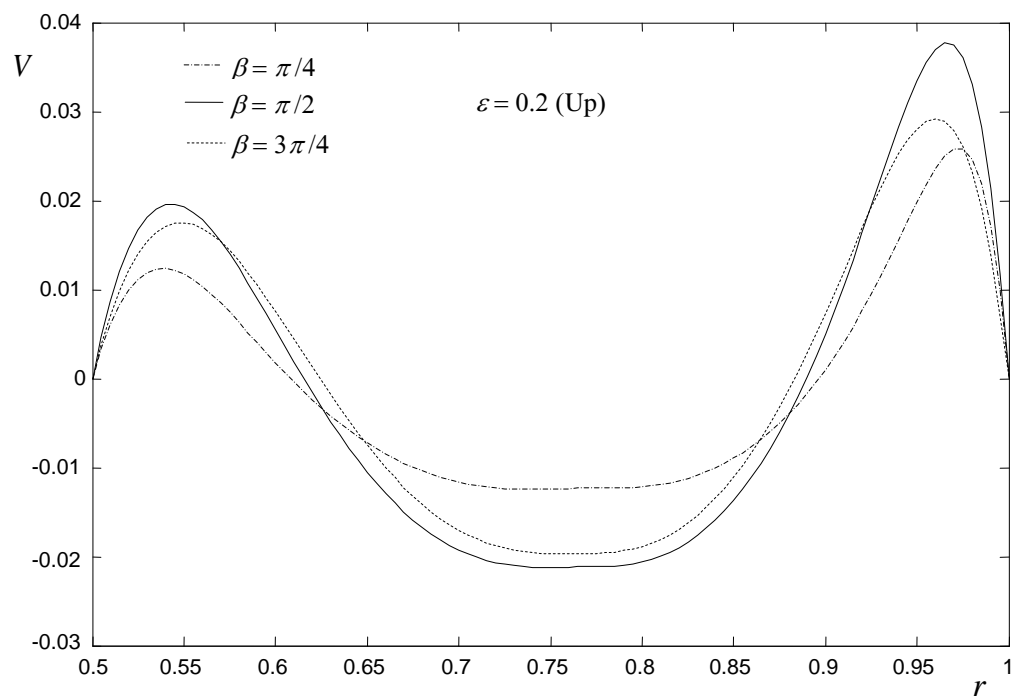

Figure 14

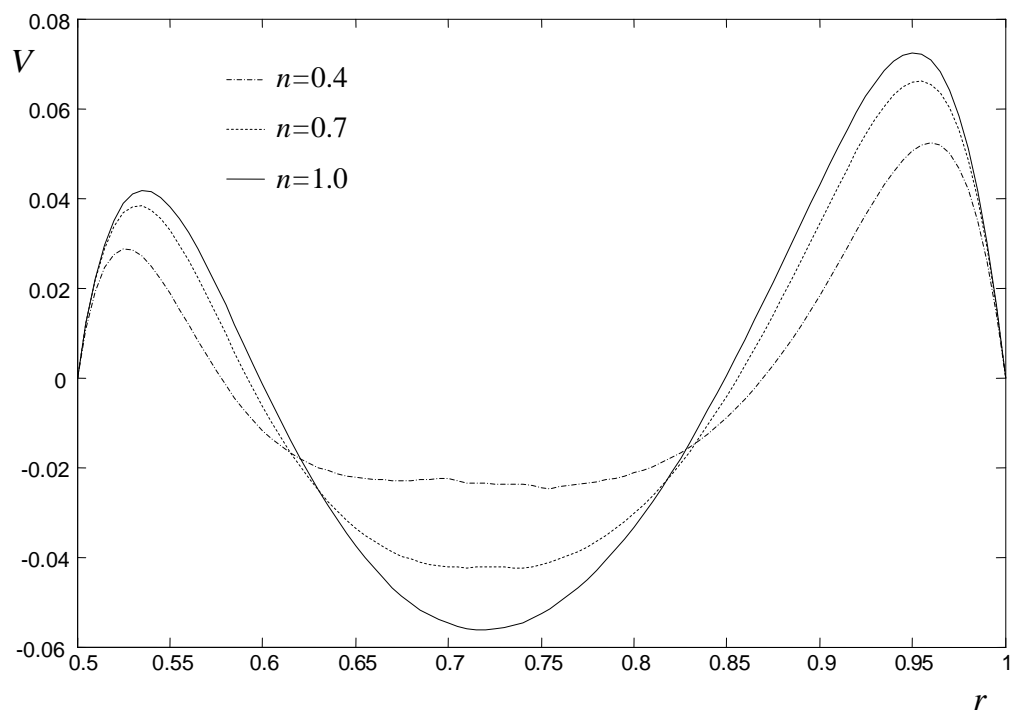
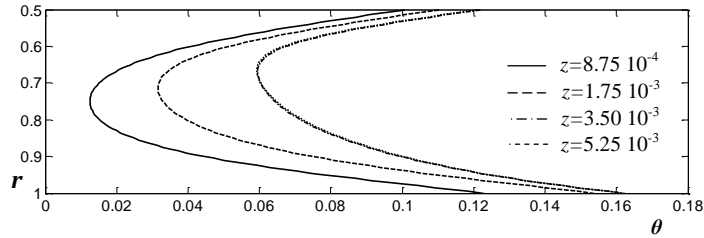
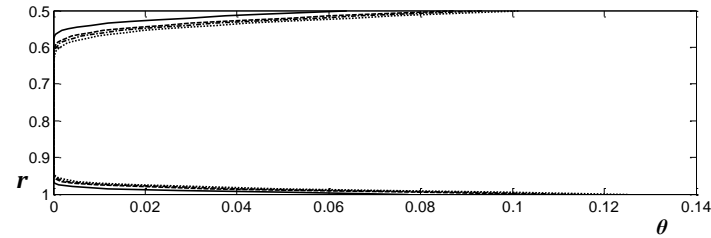
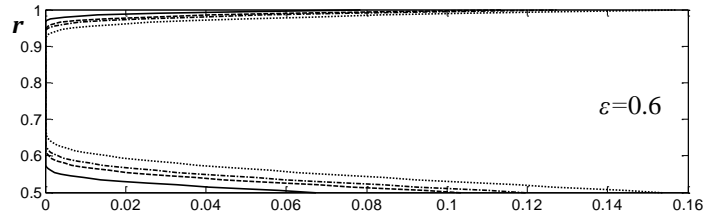
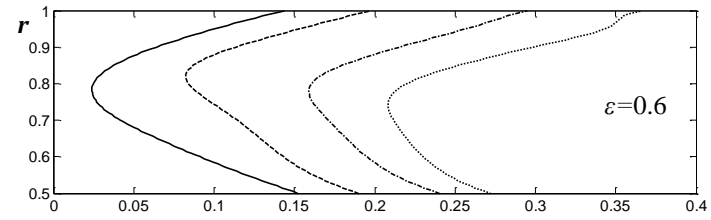
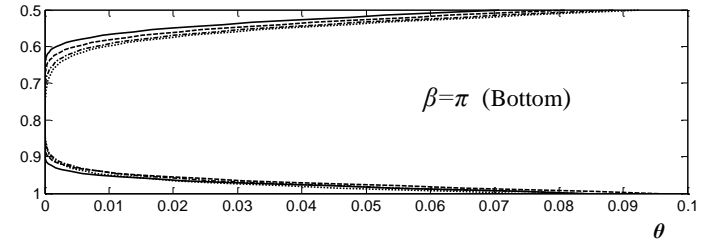
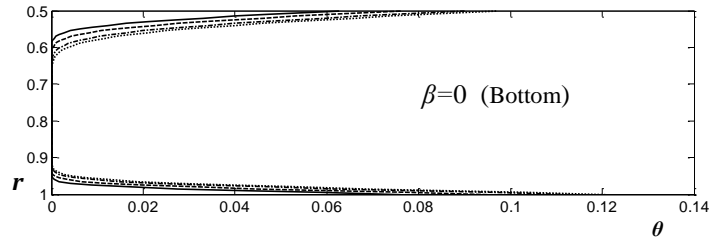
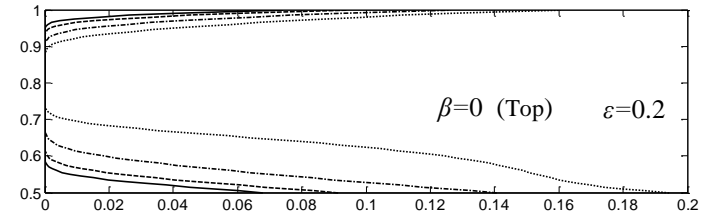
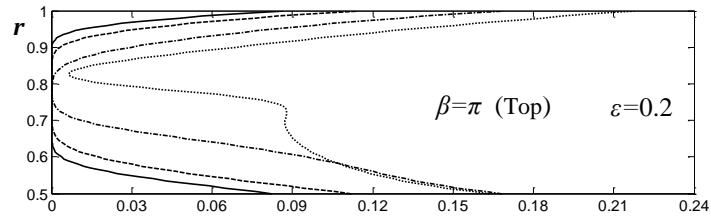

Figure 15



(a) Upward Shift

(b) Downward Shift

Figure 16

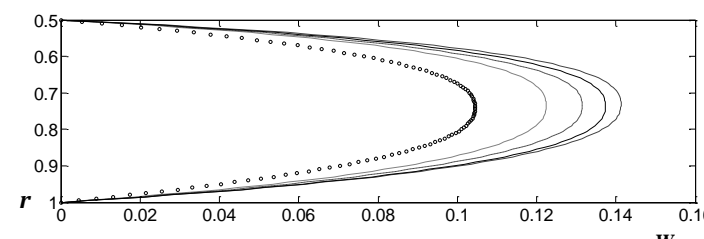
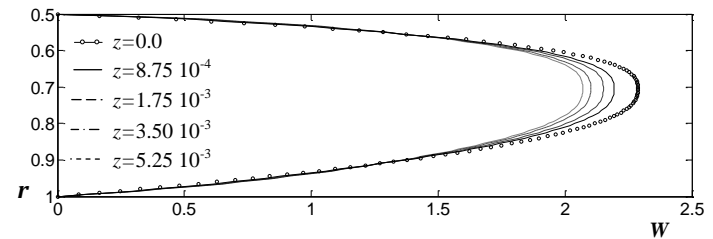
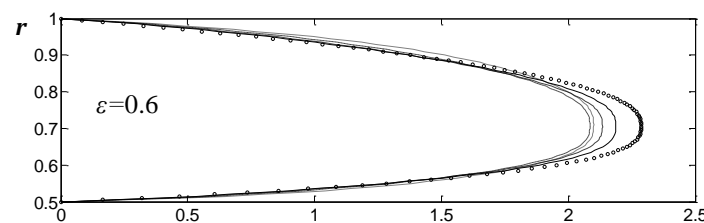
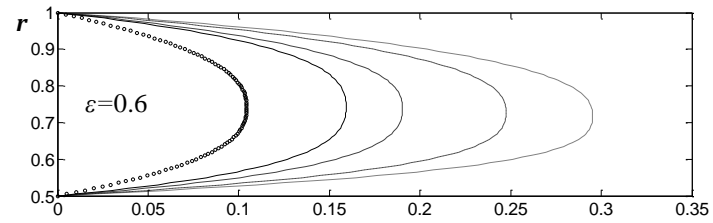
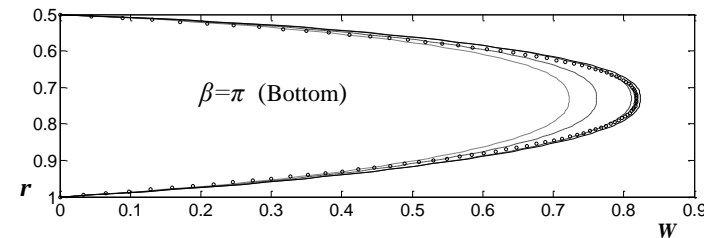
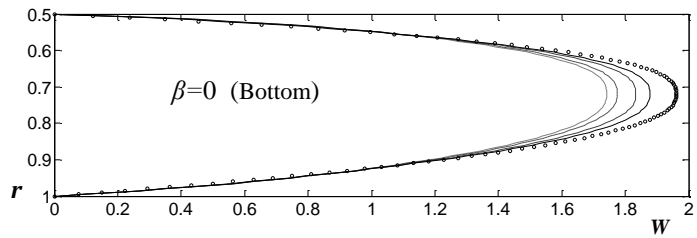
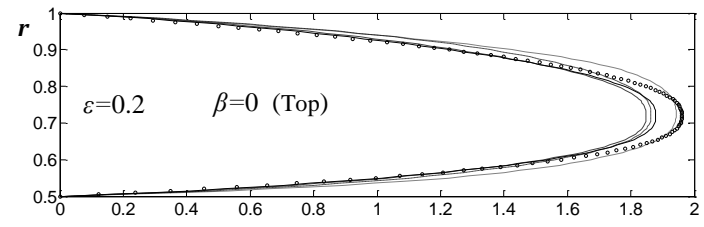
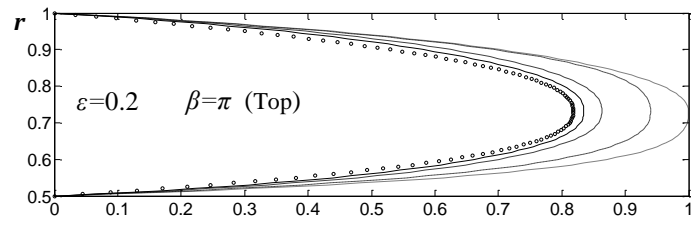

(a) Upward Shift

(b) Downward Shift



Figure 17

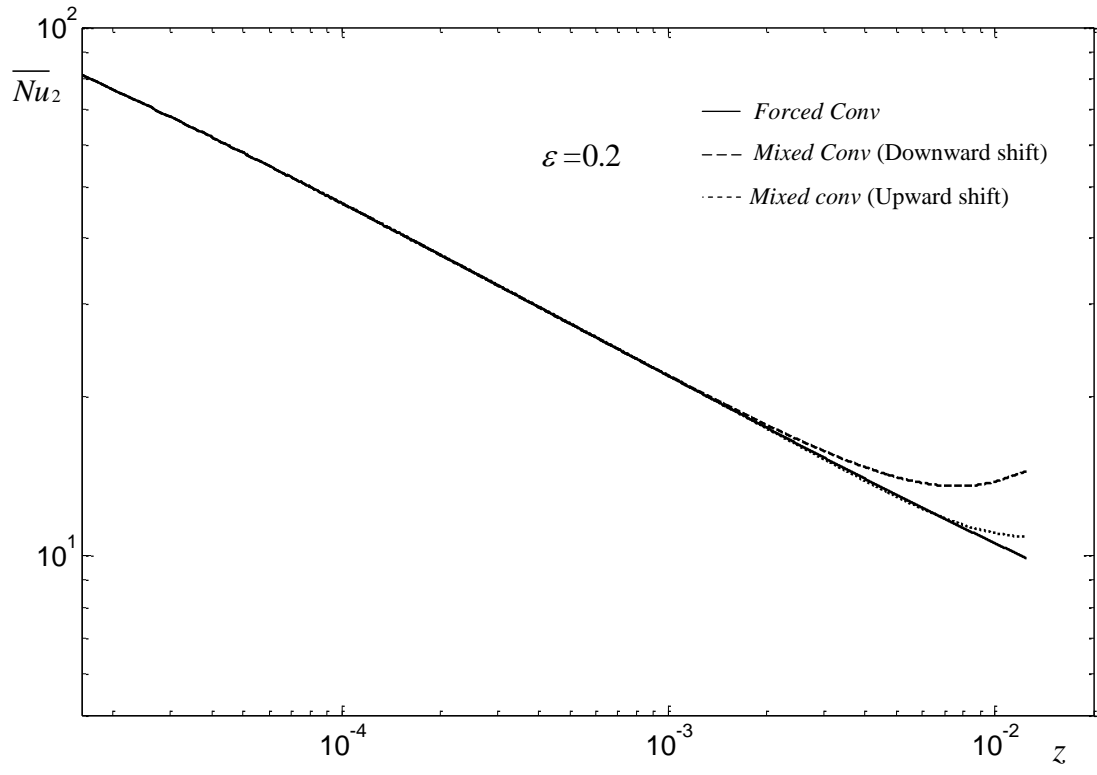
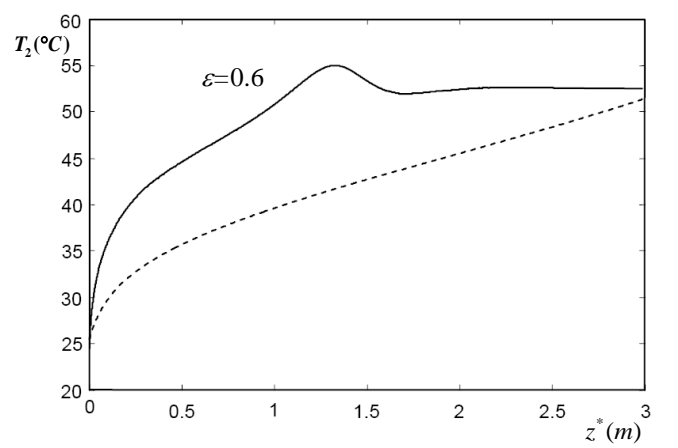
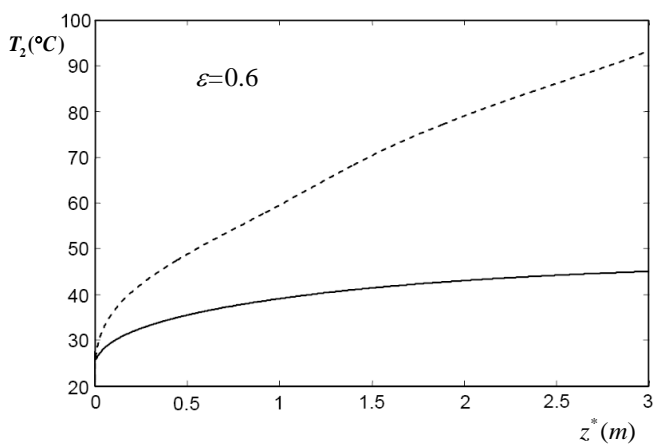
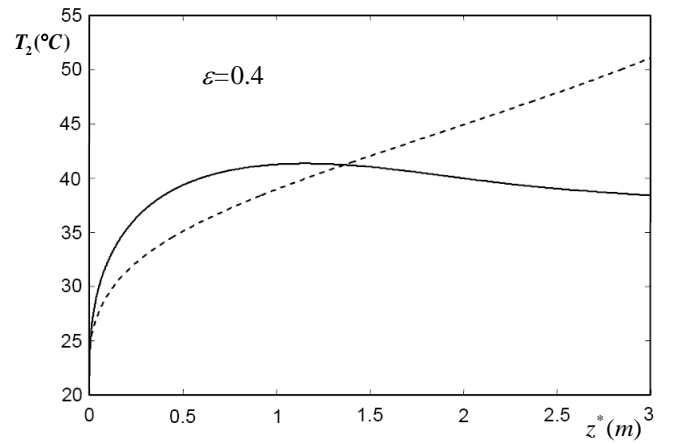
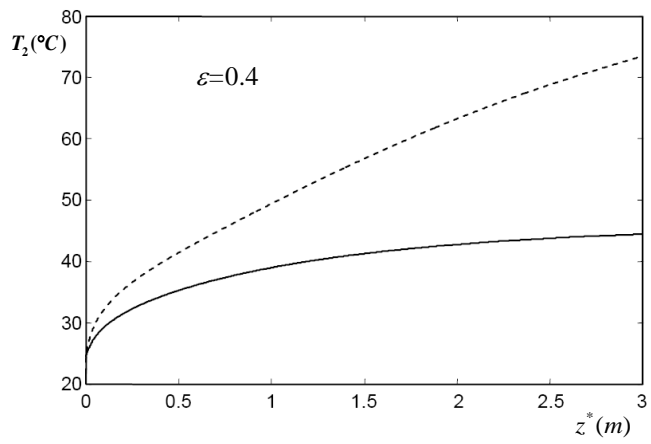
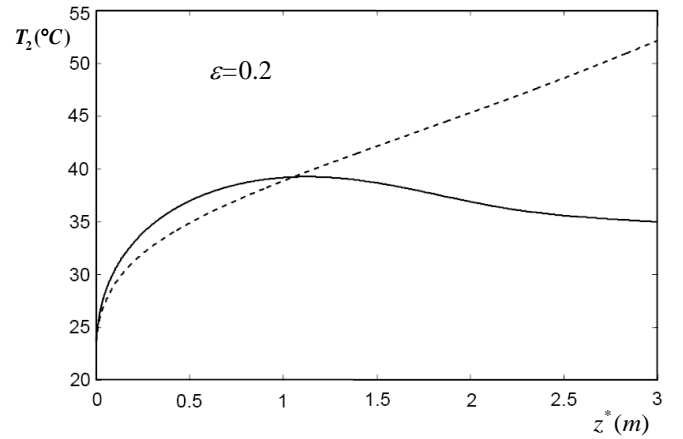
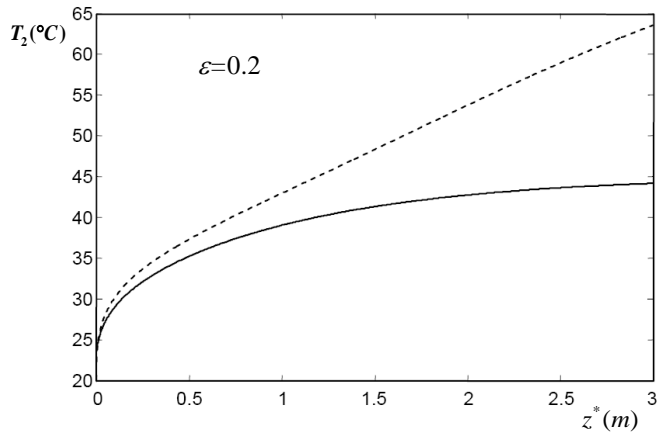

Figure 18



(a) Upward Shift

(b) Downward Shift

Figure 19

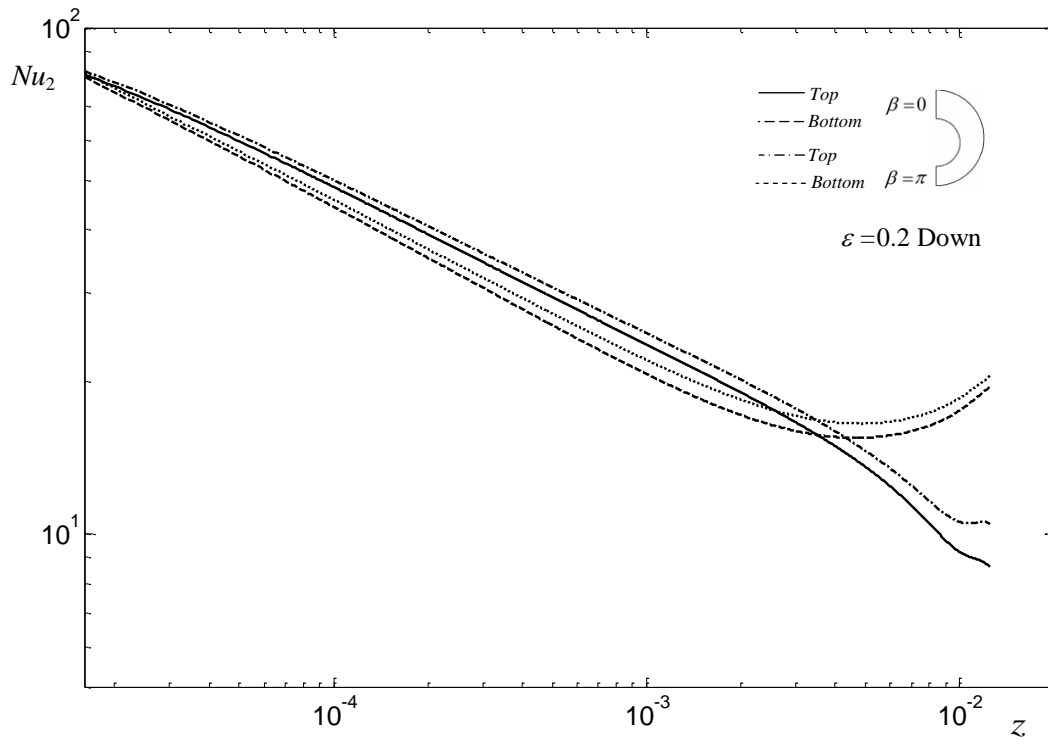

(a)

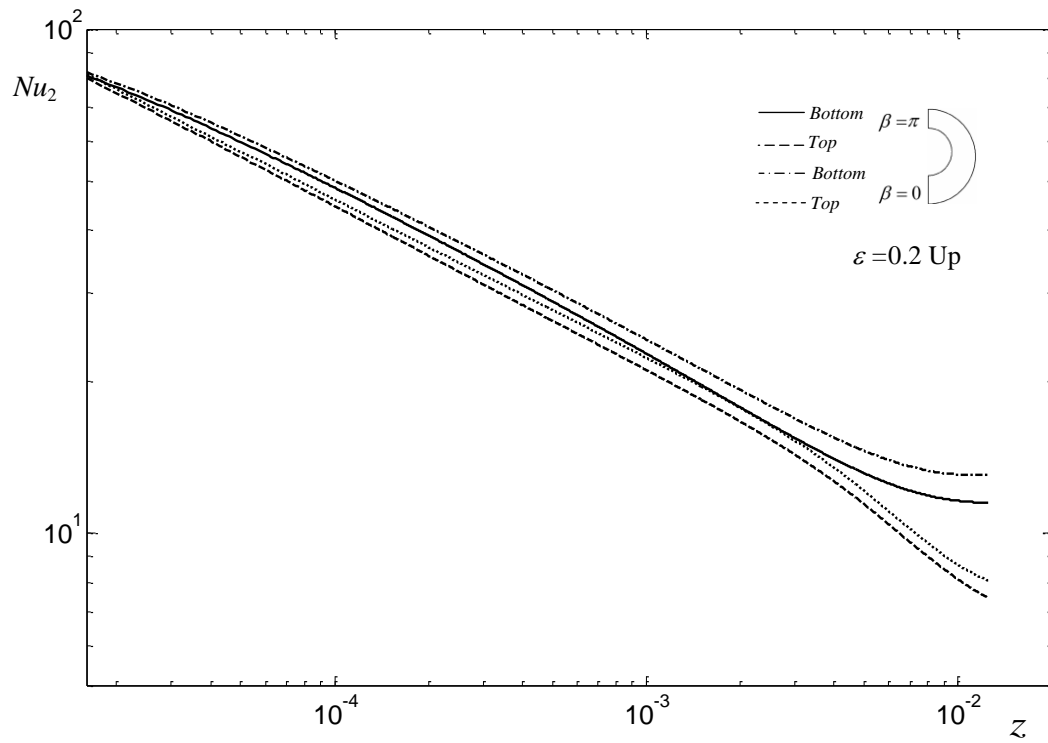

(b)